

Fill your toy box with things that start with the letter X, or have the letter X in them!

Color the things that start with the letter X, or have the letter X in them.
Cut them out, and paste them on the toy box page.

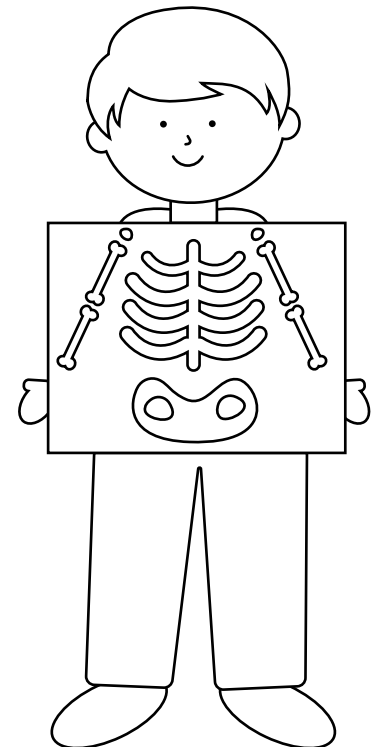
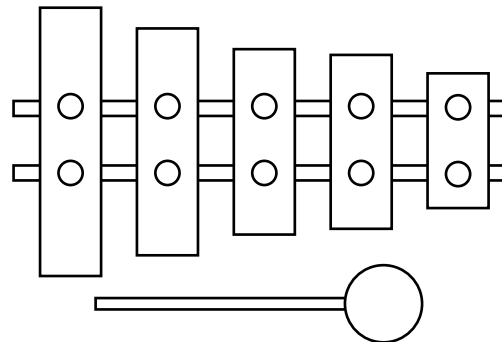
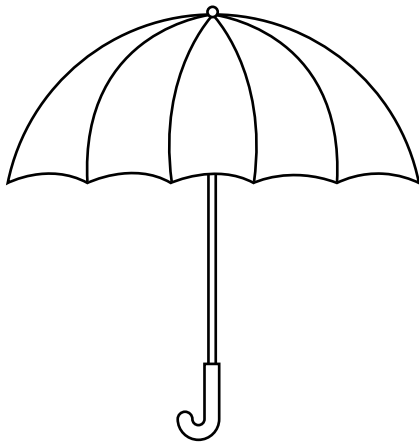
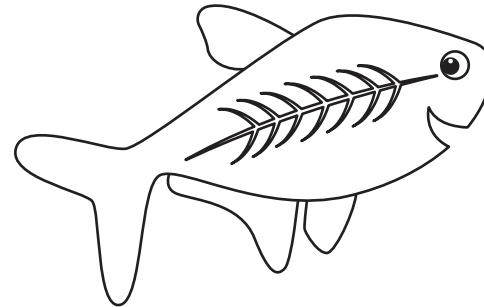
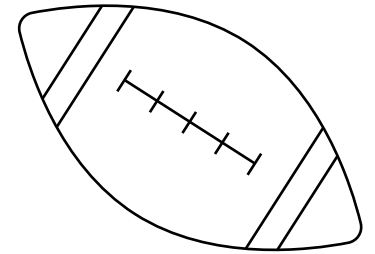
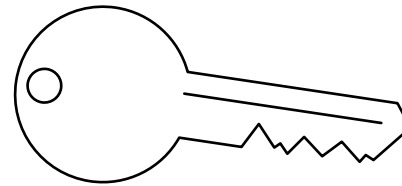
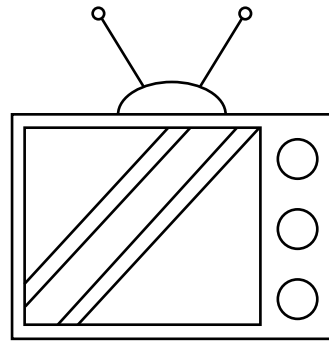
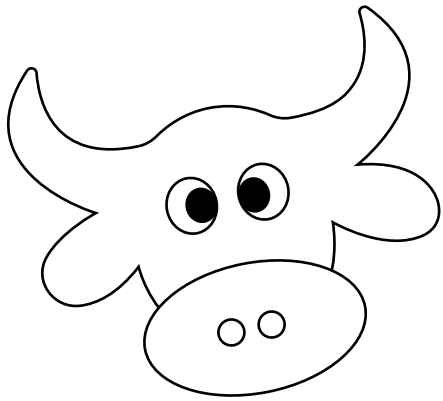

THE LETTER X
TOYS