

# ALPHABET CROWN

Color the pictures and trace the words. Cut around the dotted lines. Attach the bottom band to the top band with tape, glue, or staples to make a crown fitted to the student.

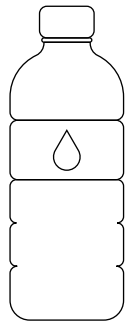

water

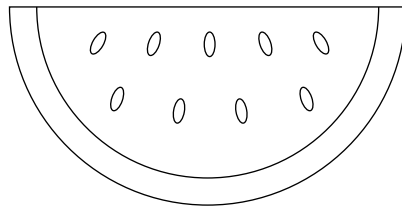

watermelon



watch

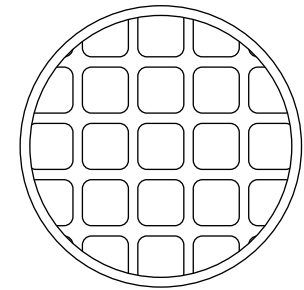

waffle

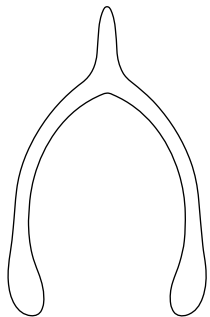

wishbone

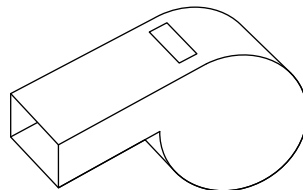

whistle

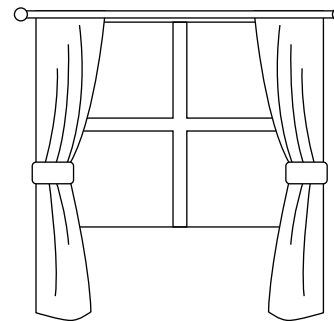

window

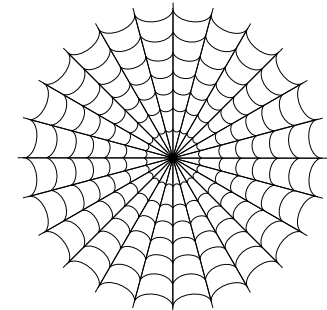

web