

ALPHABET CROWN

Color the pictures and trace the words. Cut around the dotted lines. Attach the bottom band to the top band with tape, glue, or staples to make a crown fitted to the student.

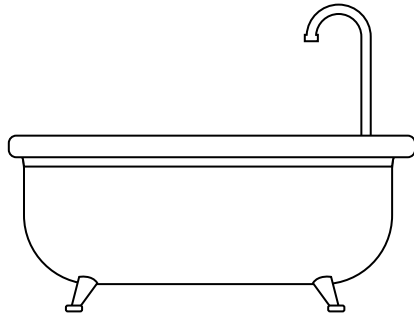

Bb



bathtub

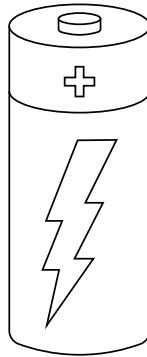

battery

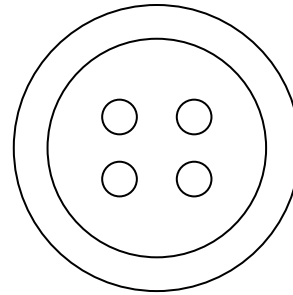

button

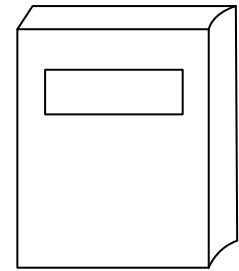

book

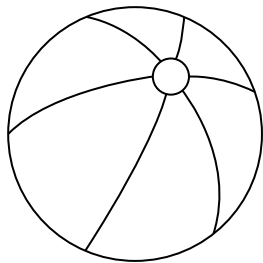

beach ball

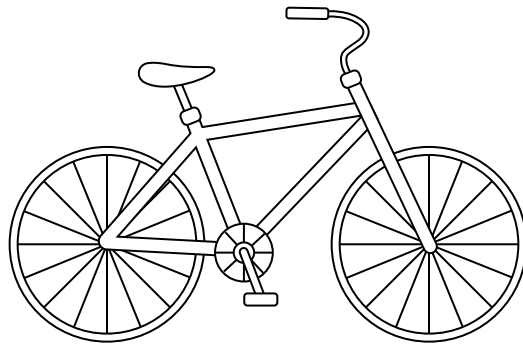

bike

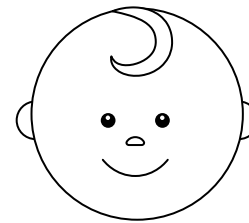

baby

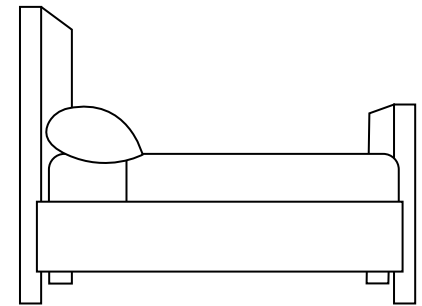

bed